

Single Phase Half Controlled Bridges

PSBZ 125

I_{dAV} = 123 A
 V_{RRM} = 400-1600 V

Preliminary Data Sheet

V_{RSM} V_{DSM}	V_{RRM} V_{DRM}	Type
500	400	PSBZ 125/04
900	800	PSBZ 125/08
1300	1200	PSBZ 125/12
1500	1400	PSBZ 125/14
*1700	*1600	PSBZ 125/16

* Delivery on request

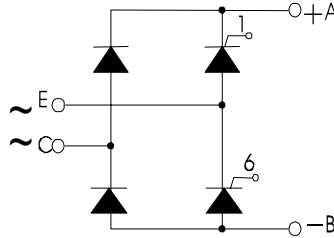

Symbol	Test Conditions	Maximum Ratings
I_{dAV}	$T_C = 85^\circ\text{C}$, module	123 A
I_{FSM}, I_{TSM}	$T_{VJ} = 45^\circ\text{C}$ $V_R = 0$ $t = 10\text{ ms}$ (50 Hz), sine	1500 A
	$t = 8.3\text{ ms}$ (60 Hz), sine	1600 A
	$T_{VJ} = T_{VJM}$ $V_R = 0$ $t = 10\text{ ms}$ (50 Hz), sine	1350 A
	$t = 8.3\text{ ms}$ (60 Hz), sine	1450 A
$\int i^2 dt$	$T_{VJ} = 45^\circ\text{C}$ $V_R = 0$ $t = 10\text{ ms}$ (50 Hz), sine	11 200 $\text{A}^2\text{ s}$
	$t = 8.3\text{ ms}$ (60 Hz), sine	10 750 $\text{A}^2\text{ s}$
	$T_{VJ} = T_{VJM}$ $V_R = 0$ $t = 10\text{ ms}$ (50 Hz), sine	9100 $\text{A}^2\text{ s}$
	$t = 8.3\text{ ms}$ (60 Hz), sine	8830 $\text{A}^2\text{ s}$
$(di/dt)_{cr}$	$T_{VJ} = T_{VJM}$ $f = 400\text{ Hz}$, $t_p = 200\mu\text{s}$ $V_D = 2/3 V_{DRM}$ $I_G = 0.3\text{ A}$ $di_G/dt = 0.3\text{ A}/\mu\text{s}$	repetitive, $I_T = 50\text{ A}$ 500 $\text{A}/\mu\text{s}$
		non repetitive, $I_T = 1/3 \cdot I_{dAV}$ 500 $\text{A}/\mu\text{s}$
$(dv/dt)_{cr}$	$T_{VJ} = T_{VJM}$ $R_{GK} = \infty$, method 1 (linear voltage rise)	$V_{DR} = 2/3 V_{DRM}$ 1000 $\text{V}/\mu\text{s}$
P_{GM}	$T_{VJ} = T_{VJM}$ $I_T = I_{TAVM}$	$t_p = 30\mu\text{s}$ $\leq 10\text{ W}$
		$t_p = 500\mu\text{s}$ $\leq 5\text{ W}$
P_{GAVM}		0.5 W
V_{RGM}		10 V
T_{VJ}		-40 ... + 125 $^\circ\text{C}$
T_{VJM}		125 $^\circ\text{C}$
T_{stg}		-40 ... + 125 $^\circ\text{C}$
V_{ISOL}	50/60 HZ, RMS $t = 1\text{ min}$	2500 V ~
	$I_{ISOL} \leq 1\text{ mA}$ $t = 1\text{ s}$	3000 V ~
M_d	Mounting torque (M6)	5 Nm
	Terminal connection torque (M6)	5 Nm
Weight	typ.	270 g

Features

- Package with screw terminals
- Isolation voltage 3000 V~
- Planar glasspassivated chips
- Low forward voltage drop
- UL released, E 148688

Applications

- Heat and temperature control for industrial furnaces and chemical processes
- Lighting control
- Motor control
- Power converter

Advantages

- Easy to mount with two screws
- Space and weight savings
- Improved temperature and power cycling capability
- High power density

Package, style and outline

Dimensions in mm (1mm = 0.0394")

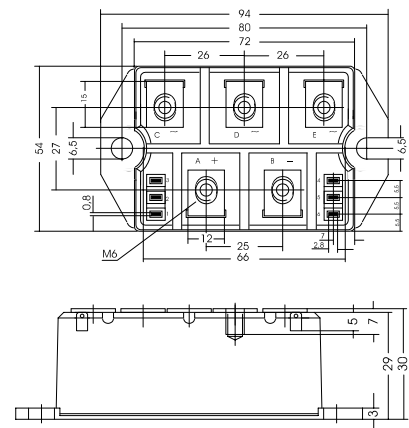

Symbol	Test Conditions	Characteristic Value			
I_D, I_R	$T_{VJ} = T_{VJM}, V_R = V_{RRM}, V_D = V_{DRM}$	\leq	5	mA	
V_T	$I_T = 200A, T_{VJ} = 25^\circ C$	\leq	1.57	V	
V_{TO}	For power-loss calculations only ($T_{VJ} = T_{VJM}$)		0.85	V	
r_T			3.5	m Ω	
V_{GT}	$V_D = 6V$	$T_{VJ} = 25^\circ C$	\leq	1.5	V
		$T_{VJ} = -40^\circ C$	\leq	1.6	V
I_{GT}	$V_D = 6V$	$T_{VJ} = 25^\circ C$	\leq	100	mA
		$T_{VJ} = -40^\circ C$	\leq	200	mA
V_{GD}	$T_{VJ} = T_{VJM} \quad V_D = 2/3 V_{DRM}$	\leq	0.2	V	
I_{GD}	$T_{VJ} = T_{VJM} \quad V_D = 2/3 V_{DRM}$	\leq	5	mA	
I_L	$T_{VJ} = 25^\circ C, t_p = 30\mu s$	\leq	450	mA	
	$I_G = 0.3A, di_G/dt = 0.3A/\mu s$				
I_H	$T_{VJ} = 25^\circ C, V_D = 6V, R_{GK} = \infty$	\leq	200	mA	
t_{gd}	$T_{VJ} = 25^\circ C, V_D = 1/2 V_{DRM}$	\leq	2	μs	
	$I_G = 0.3A, di_G/dt = 0.3A/\mu s$				
t_q	$T_{VJ} = T_{VJM}, I_T = 20A, t_p = 200\mu s, V_R = 100V$		150	μs	
	$-di/dt = 10A/\mu s, dv/dt = 15V/\mu s, V_D = 2/3 V_{DRM}$				
R_{thJC}	per thyristor; sine 180°el		0.46	K/W	
	per module		0.115	K/W	
R_{thJK}	Per thyristor; sine 180° el		0.55	K/W	
	per module		0.1375	K/W	
d_s	Creeping distance on surface		10	mm	
d_A	Creeping distance in air		9.4	mm	
a	Max. allowable acceleration		50	m/s ²	

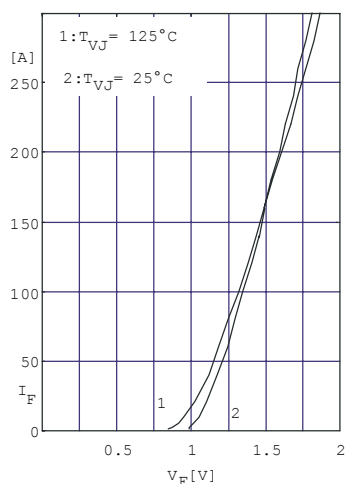

Fig. 1 Forward current vs. voltage drop per diode or thyristor

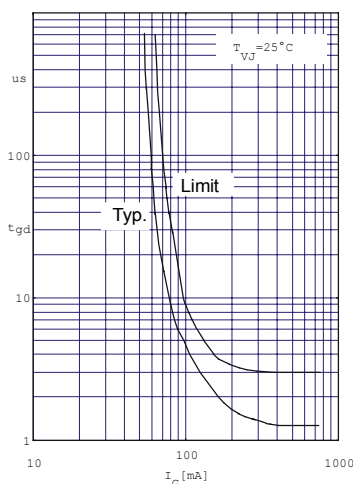

Fig. 2 Gate trigger delay time

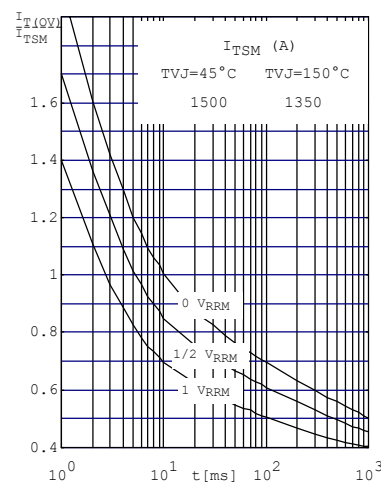

Fig. 3 Surge overload current per diode (or thyristor) I_{FSM} , I_{TSM} : Crest value t: duration



Fig.4 Gate trigger characteristic

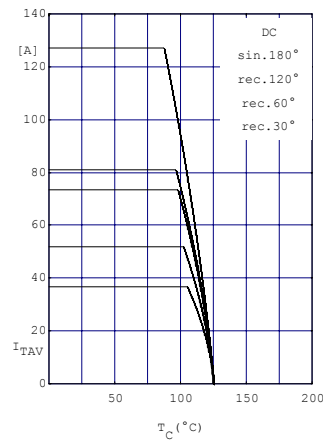

Fig.5 Maximum forward current at case temperature

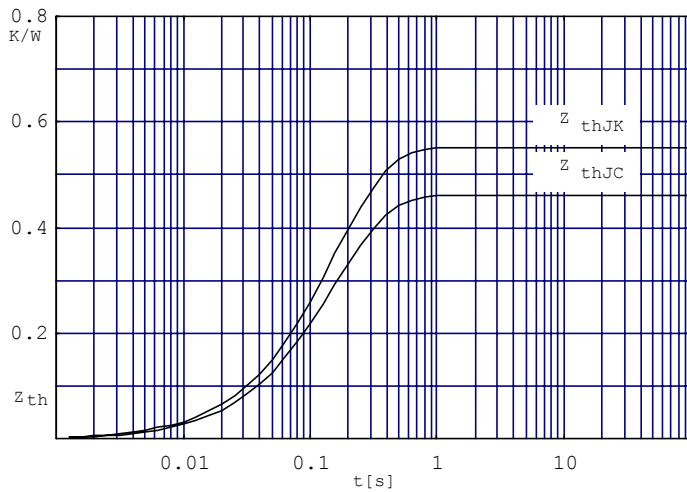

Fig.6 Transient thermal impedance per thyristor or diode (calculated)

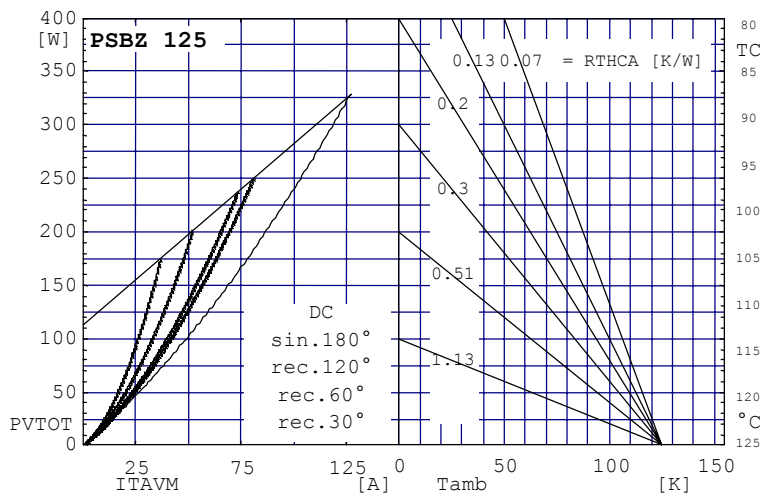

Fig. 7 Power dissipation vs. direct output current and ambient temperature